



User Guide

Quality, Design and Innovation



[home.liebherr.com/fridge-manuals](http://home.liebherr.com/fridge-manuals)



# LIEBHERR







# General safety instructions

## Contents

<b>1</b>	<b>General safety instructions.....</b>	<b>2</b>
<b>2</b>	<b>Appliance at a glance.....</b>	<b>4</b>
2.1	Scope of supply.....	4
2.2	Overview of the appliance and equipment.....	4
2.3	Special features.....	4
2.4	Range of use of appliance.....	4
2.5	Appliance noise emissions.....	5
2.6	Conformity.....	5
2.7	SVHC substances according to REACH regulation.....	5
<b>3</b>	<b>Functionality of the Touch display.....</b>	<b>5</b>
3.1	Navigation and symbol explanation.....	5
3.2	Menus.....	6
3.3	Sleep mode.....	6
<b>4</b>	<b>Putting into operation.....</b>	<b>6</b>
4.1	Switching on appliance (first use).....	6
<b>5</b>	<b>Storage.....</b>	<b>7</b>
5.1	Information regarding storage.....	7
<b>6</b>	<b>Controls.....</b>	<b>7</b>
6.1	Control and display elements.....	7
6.1.1	Status display.....	7
6.1.2	Display symbols.....	7
6.1.3	Acoustic signals.....	8
6.2	Appliance functions.....	8
6.2.1	Notes on the appliance functions.....	8
6.2.2	Switching appliance on and off.....	8
6.2.3	WiFi connection.....	9
6.2.4	LAN connection.....	10
6.2.5	Temperature.....	10
6.2.6	Temperature unit.....	11
6.2.7	Temperature recording.....	11
6.2.8	Display brightness.....	11
6.2.9	Temperature alarm.....	12
6.2.10	Door alarm.....	13
6.2.11	Alarm Sound.....	13
6.2.12	Key Sound.....	14
6.2.13	Access code.....	14
6.2.14	Language.....	15
6.2.15	Device information.....	15
6.2.16	Operating hours.....	15
6.2.17	Software.....	16
6.2.18	Sensor calibration.....	16
6.2.19	Maintenance interval reminder.....	16
6.2.20	Alarm simulation.....	16
6.2.21	Alarm forwarding.....	17
6.2.22	Demo mode.....	18
6.2.23	Resetting to factory settings.....	18
6.3	Messages.....	18
6.3.1	Warnings.....	18
6.3.2	Reminder.....	20
<b>7</b>	<b>Features.....</b>	<b>20</b>
7.1	Safety lock.....	20
7.2	Sensors.....	21
7.3	Interfaces.....	21
<b>8</b>	<b>Maintenance.....</b>	<b>21</b>
8.1	Maintenance schedule.....	21
8.2	Defrosting appliance.....	23
8.3	Cleaning the appliance.....	23
<b>9</b>	<b>Customer help.....</b>	<b>23</b>
9.1	Technical specifications.....	23
9.2	Technical fault.....	24
9.3	Customer Service.....	25
9.4	Type plate.....	25
<b>10</b>	<b>Shutting down.....</b>	<b>25</b>
<b>11</b>	<b>Disposal.....</b>	<b>25</b>
11.1	Preparing appliance for disposal.....	25

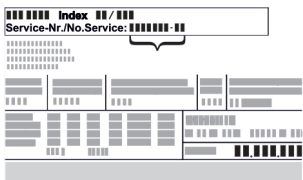
11.2	Disposing of the appliance in an environmentally friendly manner.....	25
<b>12</b>	<b>Additional information.....</b>	<b>26</b>

The manufacturer is continually working on the further development of all types and models. Please be aware that we reserve the right to make changes to the shape, equipment and technology.

Symbol	Explanation
	<b>Read instructions</b> Please read the information in these instructions carefully to understand all of the benefits of your new appliance.
	<b>Additional information on the Internet</b> The digital manual with additional information and in other languages can be found via the QR code on the front of the manual or by entering the service number at <a href="http://home.liebherr.com/fridge-manuals">home.liebherr.com/fridge-manuals</a> . The service number can be found on the serial tag:  <i>Fig. Example illustration</i>
	<b>Check appliance</b> Check all parts for transport damage. If you have any complaints, please contact your agent or customer service.
	<b>Differences</b> These instructions apply to a range of models, so differences are possible. Sections that apply to certain models only are marked with an asterisk (*).
	<b>Instructions and results</b> Instructions are marked with a ▶. Results are marked with a ▷.
	<b>Videos</b> Videos about the appliances are available on the YouTube channels of Liebherr-Hausgeräte.

### Open source licences:

The appliance contains software components that use open source licences. Information on the open source licences used can be found here: [home.liebherr.com/open-source-licences](http://home.liebherr.com/open-source-licences)

These operating instructions apply to:

- SFUsg 1001

## 1 General safety instructions

Please keep these operating instructions in a safe place so you can refer back to them at any time.

If you pass the appliance on, please hand these operating instructions to the next user.

Read these operating instructions carefully before use to ensure safe and correct use of the appliance. Follow the instructions, safety instructions and warning messages

# General safety instructions

included at all times. They are important for ensuring you can operate and install the appliance safely and without any problems.

## Danger for the user:

- This appliance may only be used by specialist and laboratory personnel who have been trained for this purpose and are familiar with all safety measures pertaining to laboratory work. Children and persons with reduced physical, sensory or mental capabilities or lack of experience and knowledge must not commission or operate this appliance.
- The socket must be easily accessible so that the appliance can be disconnected quickly from the electricity supply in an emergency. It must not be located in the area behind the appliance.
- When disconnecting the appliance from the supply, always take hold of the plug. Do not pull the cable.
- In the event of a fault pull out the mains plug or deactivate the fuse.
- **WARNING:** Do not damage the mains power cable. Do not operate the appliance with a defective mains power cable.
- **WARNING:** Multiple sockets/distributors and other electronic equipment (such as halogen transformers) must not be placed or operated at the rear of the appliance.
- **WARNING:** Keep ventilation openings, in the appliance enclosure or in the built-in structure, clear of obstruction.
- Only customer service or other specially trained staff may repair or perform other operations on the appliance.
- Only assemble, connect and dispose of the appliance according to the instructions.

## Fire hazard

- The coolant used (information on the model plate) is ecofriendly but also flammable Any leaking coolant may ignite.
  - **WARNING:** Do not damage refrigeration circuit.
  - Do not handle ignition sources inside the appliance.
  - **WARNING:** Do not use electrical appliances in the fridge compartment which do not comply with the design recommended by the manufacturer.
  - If the refrigerant leaks: remove any naked flames or ignition sources from the vicinity of the leakage point. Properly air the room. Inform customer services.
- Do not operate the appliance close to explosive gases.
- Do not store or use petrol or other flammable gases and liquids close to the appliance.
- Do not store any explosive substances, such as aerosol containers with flammable propellant gas, in the appliance. To identify these spray cans, look for the list of contents printed on the can, or a flame symbol. Gases possibly escaping may ignite due to electrical components.
- Keep burning candles, lamps and other items with naked flames away from the appliance so that they do not set the appliance on fire.
- Alcoholic liquids or other containers with alcohol inside must only be stored tightly sealed. Any alcohol that leaks out may be ignited by electrical components.

## Danger of tipping and falling:

- Do not misuse the plinth, drawers, doors etc. as a step or for support.

## Danger of frostbite, numbness and pain:

- Avoid prolonged skin contact with cold surfaces or refrigerated/frozen goods or take protective measures, e.g. wear gloves.

## Danger of injury and damage:

- **WARNING:** Do not use mechanical equipment or other methods to speed up the defrosting process other than those recommended by the manufacturer.
- **WARNING:** Risk of injury due to electric shock! There are live electrical parts under the cover.
- **NOTICE:** Appliance must only be used using original manufacturer accessories or using accessories from other providers approved by the manufacturer. The user bears the risk of using accessories which are not approved.

## Risk of crushing

- Do not hold the hinge when opening and closing the door. Fingers may get caught.

## Specialist personnel qualifications:

The appliance may only be installed, tested, maintained, and commissioned by specialist personnel who are familiar with the installation, commissioning, and operation of the appliance.

Specialist personnel are persons who, on account of their specialist training, knowledge and experience as well as their knowledge of the relevant standards, are able to assess and perform the work assigned to them and identify potential hazards. They must have training, instruction, and authorisation to work on the appliance.

## Symbols on the appliance:



This symbol may be located on the compressor. It relates to the oil in the compressor and makes reference to the risk that: **Swallowing or inhaling can be fatal.** This advice is only relevant to recycling. There is no danger in normal operation.



**WARNING:** Danger of fire / flammable materials. This symbol is located on the compressor and indicates the danger of flammable materials. Do not remove the sticker.

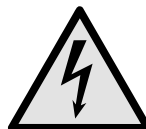

The symbol is located on the back of the appliance near the alarm relay and indicates the following danger: **Electric shock!** Even if an appliance is disconnected from the mains there may still be extraneous voltage. Do not remove sticker.



This or a similar sticker may be located on the rear of the appliance. This sticker indicates that there are vacuum insulation panels (VIP) or perlite panels in the door and/or housing. This advice is only relevant to recycling. Do not remove the sticker.



**WARNING: Cold surface!** Only touch with suitable hand protection.

This or similar sticker may be on the appliance and indicates the danger of frostbite.

## Please note the warning messages and other specific advice in the other chapters:

	<b>DANGER</b>	Indicates an immediately hazardous situation which will lead to death or serious injuries if it is not avoided.
	<b>WARNING</b>	Indicates a hazardous situation which will lead to death or serious injuries if it is not avoided.

# Appliance at a glance

	<b>CAUTION</b>	Indicates a hazardous situation which will lead to minor or moderate injuries if it is not avoided.
	<b>NOTICE</b>	Indicates a hazardous situation which may lead to damage to property if it is not avoided.
	<b>Note</b>	Indicates useful instructions and tips.

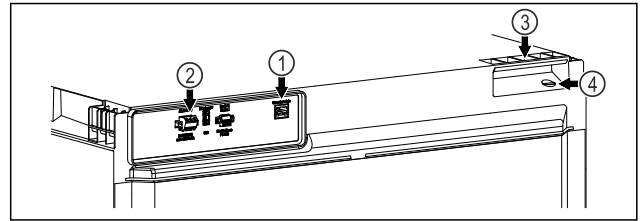

Fig. 2 Example illustration, rear end

### Equipment

- |                                 |                         |
|---------------------------------|-------------------------|
| (1) LAN/WLAN interface*         | (3) Carry aid           |
| (2) Potential-free alarm output | (4) Sensor feed-through |

## 2 Appliance at a glance

### 2.1 Scope of supply

Check all parts for transport damage. If you have any complaints, please contact your dealer or Customer Service. (see 9.3 Customer Service)

The delivery comprises the following parts:

- Free-standing appliance
- Equipment \*
- Installation materials \*
- Operating instructions
- Service brochure
- Quality certificate \*
- Mains cable

### 2.2 Overview of the appliance and equipment

SFUsg 1001

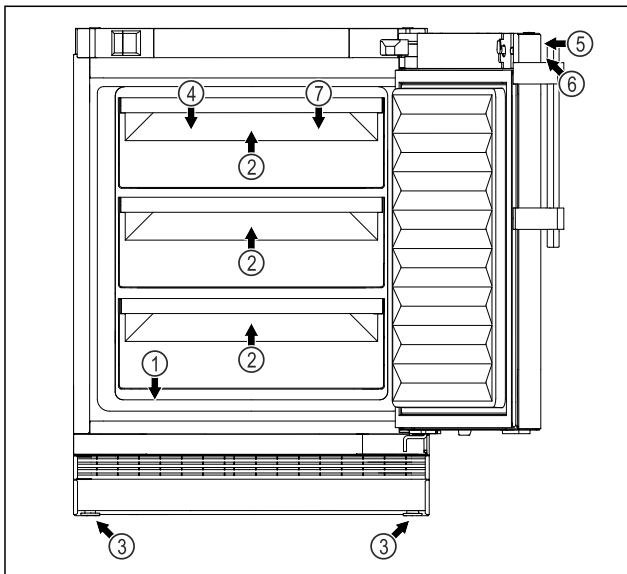

Fig. 1 Example illustration, front end

### Equipment

- |                               |                                      |
|-------------------------------|--------------------------------------|
| (1) Type plate                | (5) Lock                             |
| (2) Drawer                    | (6) Controls and temperature display |
| (3) Adjustable foot / roller* | (7) C sensor                         |
| (4) Sensor feed-through       |                                      |

### 2.3 Special features

#### Note

You can obtain accessories from customer service (see 9.3 Customer Service) or from specialised dealers via the dealer search on our service page on the Internet:

[home.liebherr.com](http://home.liebherr.com)

#### SmartModule

The appliance can be equipped with a SmartModule. It is a WLAN and LAN interface for the connection between the appliance and an external documentation and alarm system such as Liebherr SmartMonitoring dashboard.

Liebherr SmartMonitoring dashboard is not available in all countries. Check availability via the QR code (see 6.2.3 WiFi connection ) by entering your model.

#### Retrofitting drawers

When retrofitting drawer systems in Liebherr refrigerators/freezers that are used to store temperature-sensitive materials such as medicines requiring refrigeration and refrigerated goods that are subject to special standard requirements, a temperature qualification is required. Retrofitting drawers in Liebherr refrigerators/freezers can lead to spoilage of the stored goods or damage to the stored goods. Therefore, retrofitting must only be carried out by authorised service providers of the refrigerator/freezer manufacturer.

#### Retrofitting of sensors

This appliance has a sensor feed-through on the rear side, which is sealed with a plastic cover. You can use this sensor feed-through for your own sensors. (see 2.2 Overview of the appliance and equipment)

### 2.4 Range of use of appliance

#### Intended use

This laboratory freezer is suitable for professional storage of products at temperatures between -9 °C and -30 °C.

Typical products to be stored include research samples, reagents, laboratory inventory etc.

The storage of temperature-sensitive substances requires the use of an independent, continuous monitoring alarm system. This alarm system must be designed in such a way that a responsible person can register any alarm status so that appropriate action can be taken.

#### Foreseeable incorrect use

Do not use the appliance for the following applications:

- Storage and refrigeration of:

- Chemically unstable, flammable or corrosive substances
- Blood, plasma or other body fluids for the purpose of infusion, application or introduction in the human body.
- Use in potentially explosive atmospheres.
- Use outdoors or in areas exposed to dampness and splashing water.

Improper use of the appliances will result in goods stored being damaged or spoiled.

## Climate classes

The applicable climate class for your appliance is printed on the type plate.

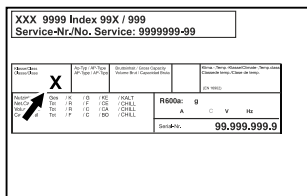

Fig. 3 Type plate

(X) This climate class indicates the ambient conditions in which the appliance can be safely operated.

Climate class (X)	max. room temperature	max. rel. humidity
7	35 °C	75%

### Note

The minimum permitted room temperature at the setup location is 10 °C.

## 2.5 Appliance noise emissions

The A-weighted emission sound pressure level during operation of the appliance is under 70 dB(A) (sound power rel. 1 pW).

## 2.6 Conformity

The coolant circuit has been tested for leak-tightness. The appliance complies with the relevant safety regulations.

The designated product complies with the provisions of the following European directives and regulations:  
 (EU) 2019/2020, 2014/35/EU, 2014/30/EU, 2011/65/EU  
 The full text of the EU Declaration of Conformity is available at the following web address: [www.liebherr.de](http://www.liebherr.de)

## 2.7 SVHC substances according to REACH regulation

You can check whether your appliance contains SVHC substances according to REACH regulation at the following link: [home.liebherr.com/de/deu/de/liebherr-erleben/nachhaltigkeit/umwelt/scip/scip.html](http://home.liebherr.com/de/deu/de/liebherr-erleben/nachhaltigkeit/umwelt/scip/scip.html)

## 3 Functionality of the Touch display

You operate your appliance using the Touch display. You select appliance functions in the Touch display (hereafter referred to as display) by tapping them. If you do not perform any action on the display for 10 seconds, the display either jumps back to the higher-level menu or directly to the status display.

### 3.1 Navigation and symbol explanation

In the illustrations, different symbols are used to navigate the display. The following table describes these symbols.

Symbol	Description
	<b>Press the Next navigation arrow:</b> Navigates to the next option in the menu.
	<b>Press the Back navigation arrow:</b> Jumps back one option in the menu.
	<b>Press and hold the Back navigation arrow for 3 seconds:</b> Jumps back to the status display in the main menu or from the Settings menu.
	<b>Press the navigation arrow several times in succession:</b> Navigates in the menu to the desired function.
	<b>Press the Confirm symbol:</b> Activates/deactivates function. Opens submenu.
	<b>Press the Confirm symbol together with the back icon:</b> Jumps back one menu level.
	<b>Arrow with clock:</b> It takes more than 10 seconds for the following message to appear in the display.
	<b>Arrow with a time indication:</b> It takes the specified amount of time until the following message appears in the display.
	<b>“Open Settings menu” symbol:</b> Navigates to the Settings menu and opens the settings menu. If necessary: Navigate to the desired function in the Settings menu. (see 3.2.1 Opening the Settings menu)

# Putting into operation

Symbol	Description
	<p><b>“Open Advanced menu” symbol:</b>                      Navigates to the Advanced menu and opens the advanced menu.                      If necessary: Navigate to the desired function in the Advanced menu.                      (see 3.2.2 Opening the Advanced menu)</p>
No action for 10 seconds	If you do not perform any action on the display for 10 seconds, the display either jumps back to the higher-level menu or directly to the status display.
Opening door and closing it again	If you open the door and immediately close it again, the display jumps directly back to the status display.

Note: Illustrations of the display are shown in the English version.

## 3.2 Menus

The appliance functions can be found in various menus.

Menu	Description
Main menu	When you switch the appliance on, you are automatically in the main menu. From here you can navigate to the most important appliance functions, to the Settings menu and to the Advanced menu.
 Settings menu	The Settings menu contains additional appliance functions for setting up your appliance. (see 3.2.1 Opening the Settings menu)
 Advanced menu	The advanced menu contains special appliance functions for setting up your appliance. Access to the Advanced menu is protected by the numerical code <b>151</b> . (see 3.2.2 Opening the Advanced menu)

### 3.2.1 Opening the Settings menu

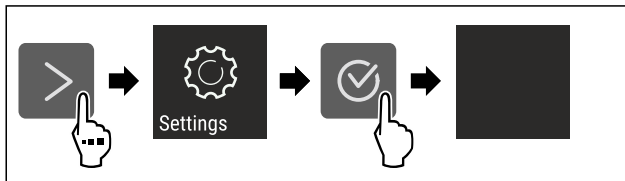

Fig. 4 Example illustration

- ▶ Carry out action steps according to the illustration.
- ▶ Settings menu is open.
- ▶ If necessary: Navigate to the desired function.

### 3.2.2 Opening the Advanced menu

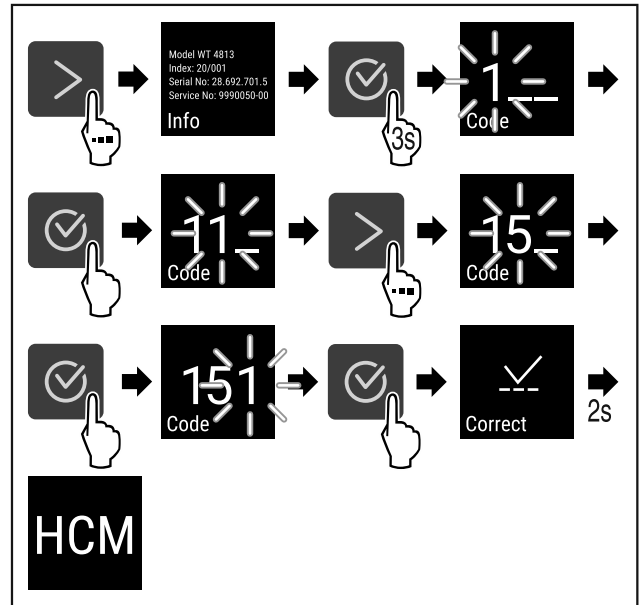

Fig. 5 Access with numerical code **151**

- ▶ Carry out action steps according to the illustration.
- ▶ The expanded menu is open.
- ▶ If necessary: Navigate to the desired function.

## 3.3 Sleep mode

If you do not touch the display for 1 minute, the display switches to sleep mode. In sleep mode, the display brightness is dimmed.

### 3.3.1 Ending sleep mode

- ▶ Press any navigation key.
- ▶ Sleep mode is ended.

## 4 Putting into operation

### 4.1 Switching on appliance (first use)

Make sure the following prerequisites are met:

- Appliance is installed and connected.
- All adhesive strips, adhesive and protective films and transport locks are removed from inside and outside the appliance.

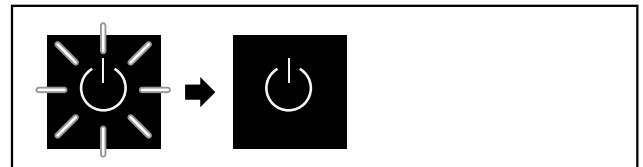

Fig. 6 Example illustration

The standby symbol flashes until the startup process is complete.

The standby symbol is shown in the display.

If the appliance has been supplied with factory settings, the screen language first needs to be selected when using for the first time.

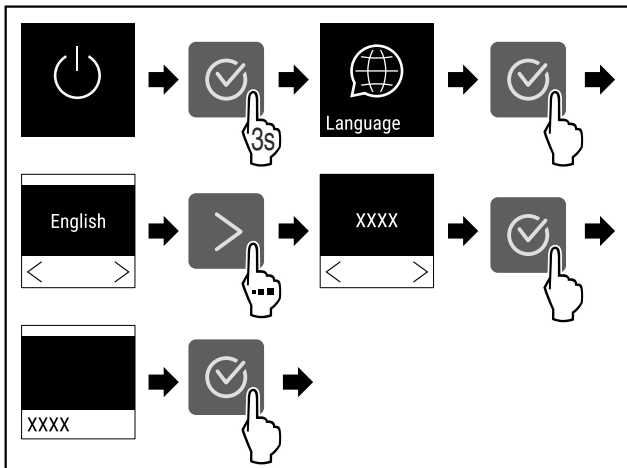

Fig. 7

► Carry out action steps according to the illustration.

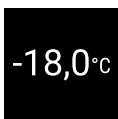

Fig. 8

- The appliance is switched on once the temperature appears in the display.
- The temperature display flashes until the set temperature is reached.

## 5 Storage

### 5.1 Information regarding storage

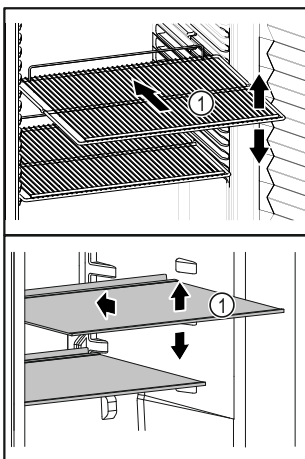

Fig. 9 Example illustration

When stocking observe the following:

- If storage surfaces Fig. 9 (1) are movable, adjust them according to height.
- Observe maximum load weight. (see 9.1 Technical specifications)
- Do not load appliance until storage temperature has been reached (maintain cold chain).
- Refrigerated goods must not touch the rear wall.
- Refrigerated items do not protrude beyond the shelves.
- Keep liquids in closed containers.
- Leave space when storing items for refrigeration to ensure good air circulation.

## 6 Controls

### 6.1 Control and display elements

The display provides a quick overview of the current appliance status, the temperature setting, the status of functions and settings as well as alarm and error messages.

It is operated using the navigation arrows and confirmation symbol.

Functions can be activated or deactivated and setting values can be changed.



Fig. 10 Display

(1) Status display

(3) Forwards navigation arrow

(2) Backwards navigation arrow

(4) Confirm

#### 6.1.1 Status display



Fig. 11 Status display with actual temperature

The status display shows the actual temperature and is the home display. You navigate from here to the other functions and settings. The status display may show a range of display symbols.

#### 6.1.2 Display symbols

Display symbols provide information about the status of the appliance.

Symbol	Appliance status
	<b>Standby</b> Appliance is switched off.
	<b>Flashing standby symbol</b> Appliance is starting up.
	<b>Flashing temperature</b> Target temperature not yet reached. Appliance cooling to temperature set.

# Controls

Symbol	Appliance status
	<b>Temperature display</b> Displays the current interior temperature
	<b>D in the display</b> Appliance is in DemoMode.
	<b>Maintenance reminder</b> The time interval set has expired.
	<b>Data memory full</b> The data memory (999 hours) is full. From now, the oldest data will be overwritten.
	<b>Flashing symbol</b> A fault is still active.
	<b>Error symbol</b> Appliance is in error state.
	<b>White bar at the bottom</b> Submenu
	<b>White bar at the top</b> Default, active setting or active value
	<b>Increasing bar</b> Press button for 3 seconds to activate setting.
	<b>Decreasing bar</b> Press button for 3 seconds to deactivate setting.

Status display symbols

## 6.1.3 Acoustic signals

A signal sounds in the following cases:

- If a function or a value is confirmed.
- If a function or a value can either not be activated or not deactivated.
- As soon as an error occurs.
- If there is an alarm message.

The alarms can be switched on and off in the customer menu.

## 6.2 Appliance functions

### 6.2.1 Notes on the appliance functions

The appliance functions are set at the factory so that your appliance is fully functional.

Before you alter, activate or deactivate the device functions, make sure that the following requirements are met:

- You have read and understood the descriptions of how the display works. (see 3 Functionality of the Touch display)
- You have familiarised yourself with the operating and display elements of your appliance. (see 6.1 Control and display elements)

### 6.2.2 Switching appliance on and off



Using this setting the entire appliance can be switched on and off.

#### Switching on appliance

Without activated DemoMode:



Fig. 12

► Carry out action steps according to the illustration.

With activated DemoMode:

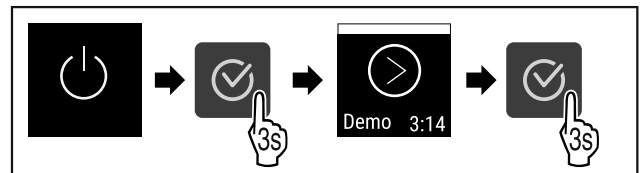

Fig. 13

► Carry out action steps according to the illustration.

#### Note

Deactivate DemoMode before countdown finishes.

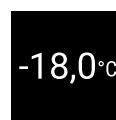

Fig. 14

► The temperature appears in the display.

#### Switching off appliance

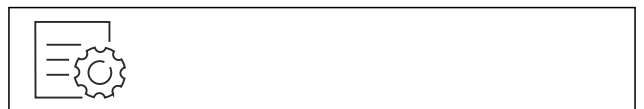

Fig. 15

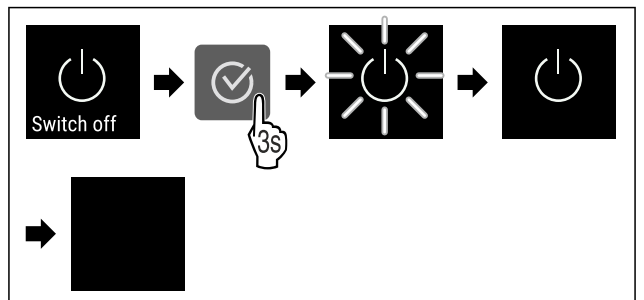

Fig. 16

► Carry out action steps according to the illustration.

► Standby symbol is shown in the display.

► Display switches off after approximately 10 minutes.

## 6.2.3 WiFi connection



### Note

Liebherr SmartMonitoring Dashboard is not available in all countries. Check availability via the QR code by entering your model.

### Note

Use of the Liebherr SmartMonitoring Dashboard at <https://smartmonitoring.liebherr.com> requires installation of a SmartModule and a commercial MyLiebherr account. When commissioning online you can register using the login data you have, or register again and create a company account.

This setting establishes a wireless connection between the appliance and the internet. The connection is controlled via the SmartModule. The appliance can be integrated via the browser-based [Liebherr SmartMonitoring Dashboard](#) and advanced options as well as customised methods relating to control, administration and monitoring can be used.

### Note

You can obtain accessories from customer service (see 9.3 Customer Service) or from specialised dealers via the dealer search on our service page on the Internet:

[home.liebherr.com](http://home.liebherr.com)

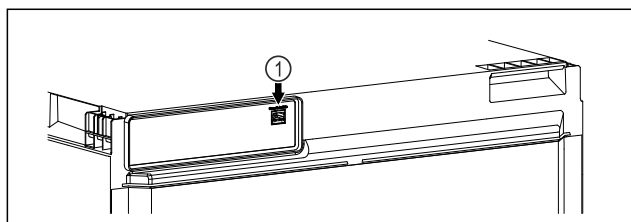

Fig. 17

Make sure that the following requirements are fulfilled:

- SmartModule Fig. 17 (1) has been inserted.

### Establishing connection

You commission and set up your SmartModule online via the [Liebherr SmartMonitoring Dashboard](#) on your web-enabled device.

On the [Liebherr SmartMonitoring Dashboard](#), information is also available about retrofitting the SmartModule.



Fig. 18

- Open the [Liebherr SmartMonitoring Dashboard](#) (see Fig. 18).

On the refrigerator or freezer:



Fig. 19

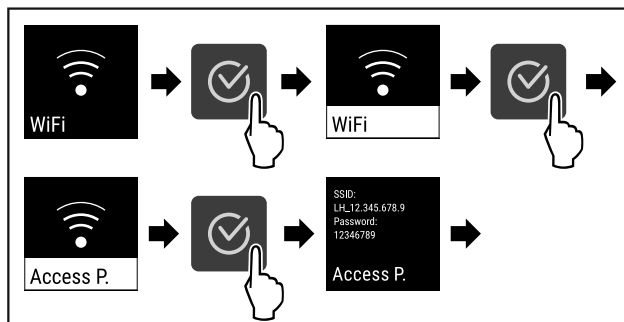

Fig. 20

- Carry out action steps according to the illustration.
- Continue the set-up procedure on your web-enabled device: [Liebherr SmartMonitoring Dashboard](#)

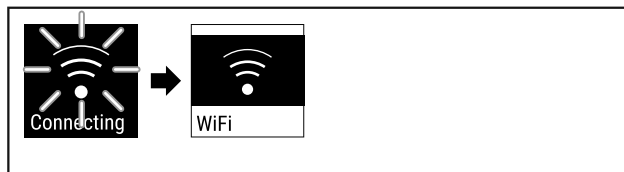

Fig. 21

- Connection is established.
- WiFi connecting appears. The symbol flashes.
- Follow the [Liebherr SmartMonitoring Dashboard](#) instructions.
- Connection is established.

### Disconnecting

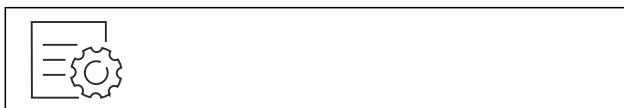

Fig. 22

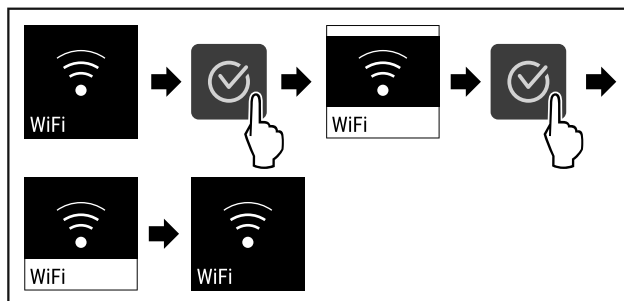

Fig. 23

- Carry out action steps according to the illustration.
- There is no connection.

### Resetting connection

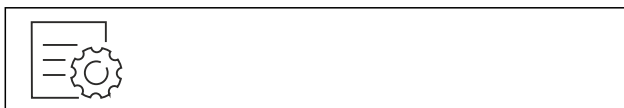

Fig. 24

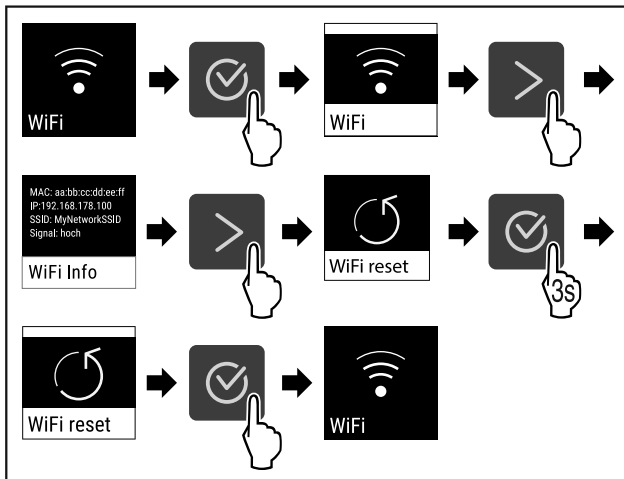

Fig. 25

- ▶ Carry out action steps according to the illustration.
- ▷ The WiFi settings are restored to the factory settings.



## 6.2.4 LAN connection

### Note

Liebherr SmartMonitoring Dashboard is not available in all countries. Check availability via the QR code by entering your model.

### Note

Use of the Liebherr SmartMonitoring Dashboard at <https://smartmonitoring.liebherr.com> requires installation of a SmartModule and a commercial MyLiebherr account. When commissioning online you can register using the login data you have, or register again and create a company account.

This setting establishes a wired connection between the appliance and the internet. The connection is controlled via the SmartModule. The appliance can be integrated via the browser-based Liebherr SmartMonitoring Dashboard and advanced options as well as customised methods relating to control, administration and monitoring can be used.

### Note

You can obtain accessories from customer service (see 9.3 Customer Service) or from specialised dealers via the dealer search on our service page on the Internet:

[home.liebherr.com](http://home.liebherr.com)

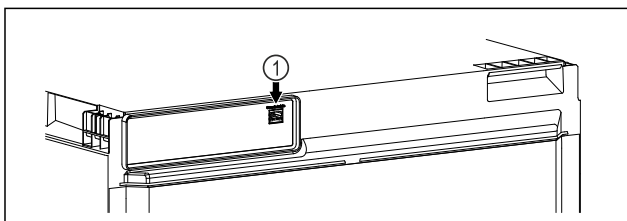

Fig. 26

Make sure that the following requirements are fulfilled:

- SmartModule Fig. 26 (1) has been inserted.
- A network cable is connected.
- The network is connected to the internet.

### Establishing connection

You commission and set up your SmartModule online via the Liebherr SmartMonitoring Dashboard on your web-enabled device.

On the Liebherr SmartMonitoring Dashboard, information is also available about retrofitting the SmartModule.



Fig. 27

- ▶ Open the Liebherr SmartMonitoring Dashboard (see Fig. 27).

On the refrigerator or freezer:



Fig. 28

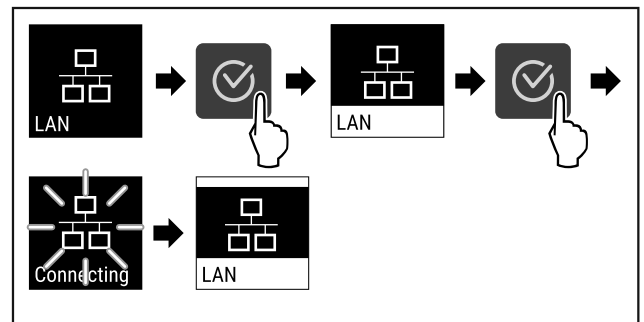

Fig. 29

- ▶ Carry out action steps according to the illustration.
- ▷ Connection is established: LAN connecting appears. The symbol flashes.
- ▶ Follow the Liebherr SmartMonitoring Dashboard instructions.
- ▷ Connection is established.

### Disconnecting

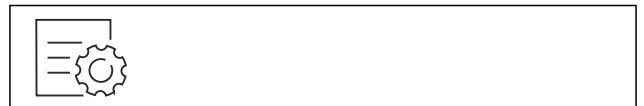

Fig. 30

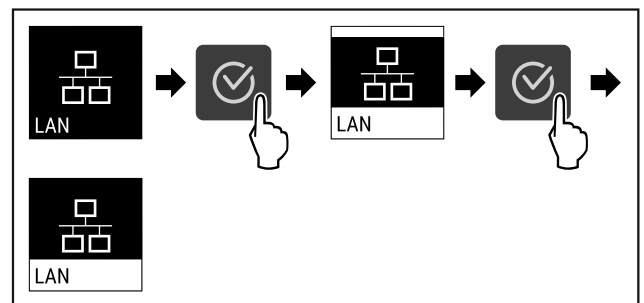

Fig. 31

- ▶ Carry out action steps according to the illustration.
- ▷ There is no connection.



## 6.2.5 Temperature

The temperature depends on the following factors:

- How often the door is opened
- How long the door is open for
- The room temperature of the installation site
- The type, temperature and amount of frozen food

## Note

The temperature may differ from the temperature displayed in some areas of the interior.

## Setting temperature

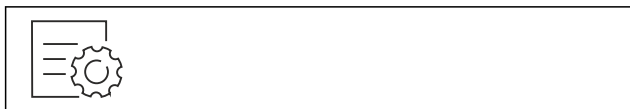

Fig. 32

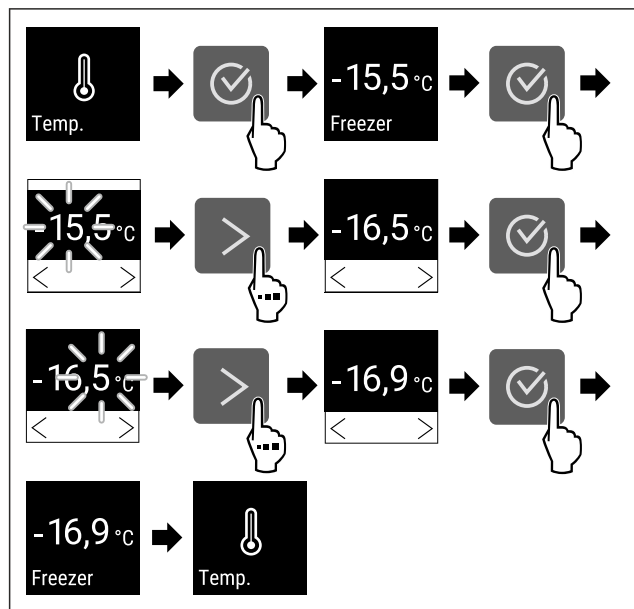

Fig. 33 Changing temperature from -15.5 °C to -16.9 °C

- ▶ Carry out action steps according to the illustration.
- ▶ Temperature is set.

## 6.2.6 Temperature unit



Use this function to set the temperature unit. You can set degrees Celsius or degrees Fahrenheit as the temperature unit.

### Setting the temperature unit



Fig. 34

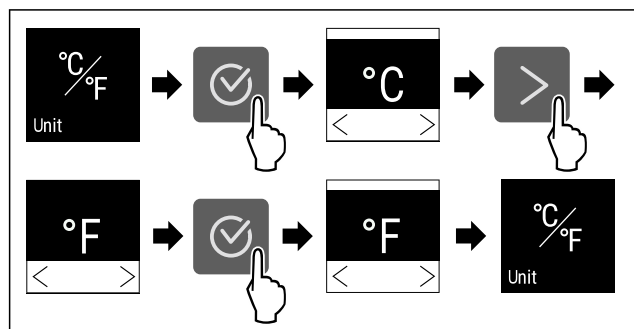

Fig. 35 Example illustration: Switch from degrees Celsius to degrees Fahrenheit.

- ▶ Carry out action steps according to the illustration.
- ▶ The temperature unit is set.

## 6.2.7 Temperature recording



The appliance displays the minimum and maximum temperatures of the interior. The recording of these temperatures starts automatically after the appliance is switched on; they are recorded at one minute intervals. A note indicating that the data memory is full is displayed after 999 hours (approx. 40 days). The temperature recording should then be reset.

## Note

We recommend resetting the temperature recording once **after reaching the set temperature** when the appliance is commissioned. This ensures that the value displayed for the maximum temperature is a meaningful value.

### Displaying temperature recording

The temperature recording displays the length of the recording and the minimum and maximum temperatures measured during this period of time.

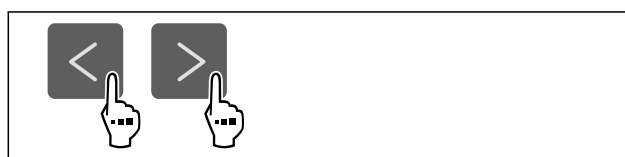

Fig. 36



Fig. 37

- ▶ Status screen with the temperature recordings is displayed.

### Resetting temperature recording

The displayed minimum and maximum temperatures can be reset at any time. This deletes the displayed values and the recording interval starts again.

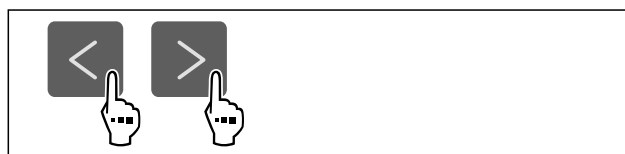

Fig. 38

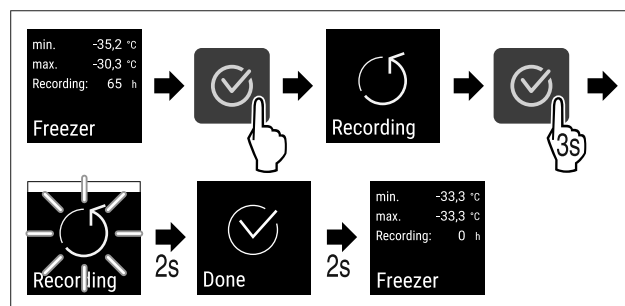

Fig. 39

- ▶ Carry out steps according to the illustration.
- ▶ Temperature recording is reset.
- ▶ Recording interval starts again.

## 6.2.8 Display brightness



Use this function to set the display brightness in stages.

# Controls

You can select the following brightness levels:

- 40 %
- 60 %
- 80 %
- 100 % (pre-setting)

## Setting the brightness



Fig. 40

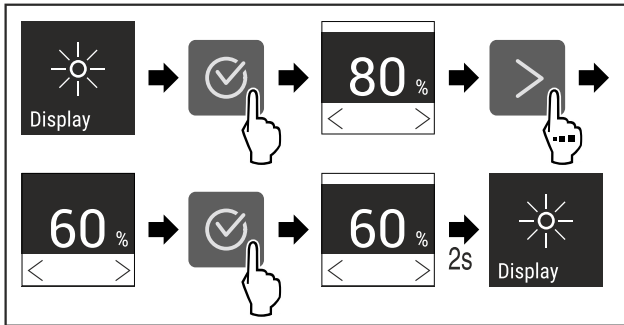

Fig. 41 Example illustration: Switch from 80 % to 60 %.

- ▶ Carry out action steps according to the illustration.
- ▷ The brightness is set.

## 6.2.9 Temperature alarm



Use this function to set the temperature alarm. You set the upper and lower temperature limits with a differential offset to the indoor temperature currently set. The temperature alarm is triggered as soon as the indoor temperature leaves the set temperature range and any set delay time has elapsed.

Example		Differential value to be set
Current indoor temperature	5 °C	
Lower temperature limit	2 °C	-3 °C
Upper temperature limit	8 °C	+3 °C

The following values can be set:

- Differential value for lower temperature limit in 0.1 °C steps
- Differential value for upper temperature limit in 0.1 °C steps
- Alarm delay time from 0 to 60 minutes (setting "0" means no temperature alarm delay.)
- Alarm repetition frequency from 0 to 30 minutes (setting "0" means no alarm repetition after confirming the alarm.)

## Setting temperature alarm



Fig. 42

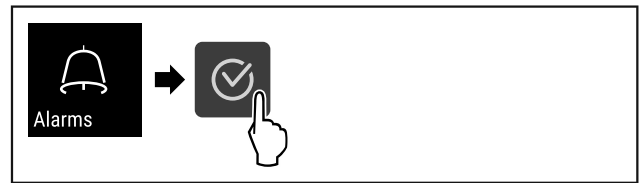

Fig. 43

- ▶ Carry out action steps according to the illustration.



Fig. 44

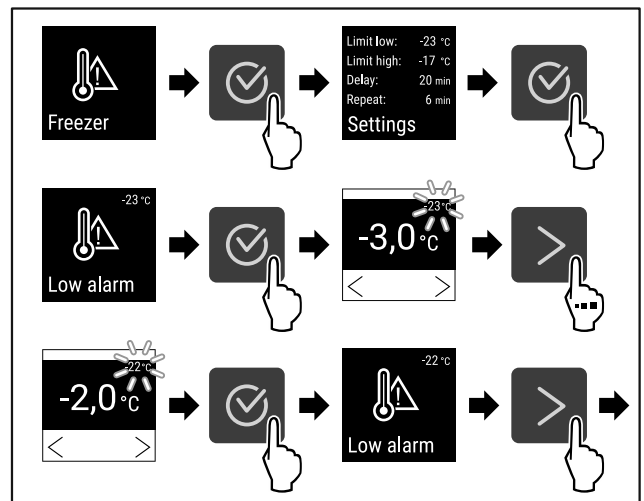

Fig. 45 Example of setting the lower temperature limit based on a set appliance temperature of -20 °C.

- ▶ Carry out action steps according to the illustration.
- ▷ Lower temperature limit has been set.

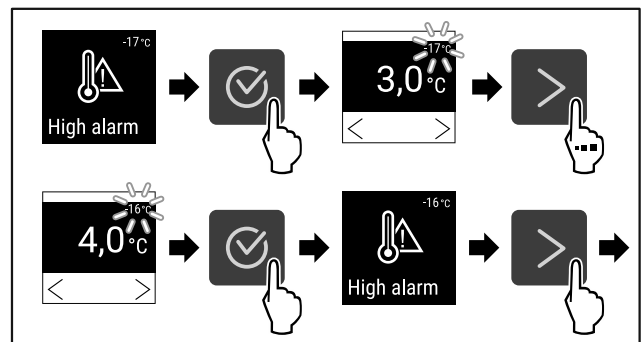

Fig. 46 Example of setting the upper temperature limit based on a set appliance temperature of -20 °C.

- ▶ Carry out action steps according to the illustration.
- ▷ Upper temperature limit has been set.

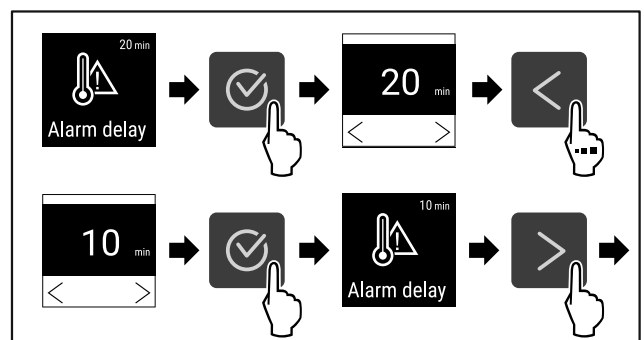

Fig. 47

- ▶ Carry out action steps according to the illustration.
- ▷ Alarm delay time has been set.

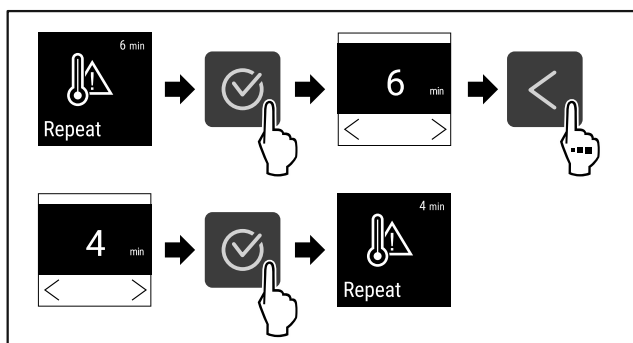

Fig. 48

- ▶ Carry out action steps according to the illustration.
- ▷ Alarm repetition interval has been set.
- ▷ Temperature alarm has been set.

### Displaying set temperature alarm values

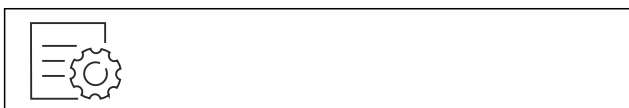

Fig. 49

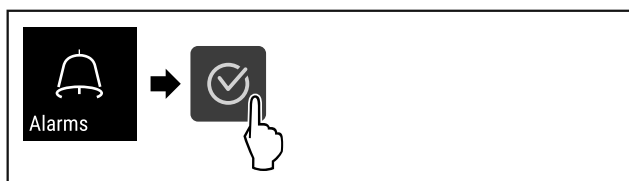

Fig. 50

- ▶ Carry out action steps according to the illustration.



Fig. 51

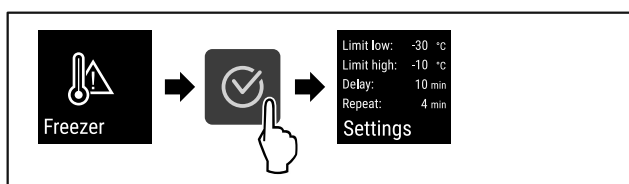

Fig. 52

- ▶ Carry out action steps according to the illustration.
- ▷ Set temperature alarm values are displayed.

### 6.2.10 Door alarm



Use this function to activate or deactivate the door alarm. The door alarm sounds if the door is open for too long. The door alarm is activated on delivery. You can set how long the door may be open before the door alarm sounds.

The following values can be set:

- 15 seconds
- 30 seconds
- 60 seconds
- 90 seconds

- 120 seconds
- 150 seconds
- 180 seconds
- Off

### Setting the door alarm



Fig. 53

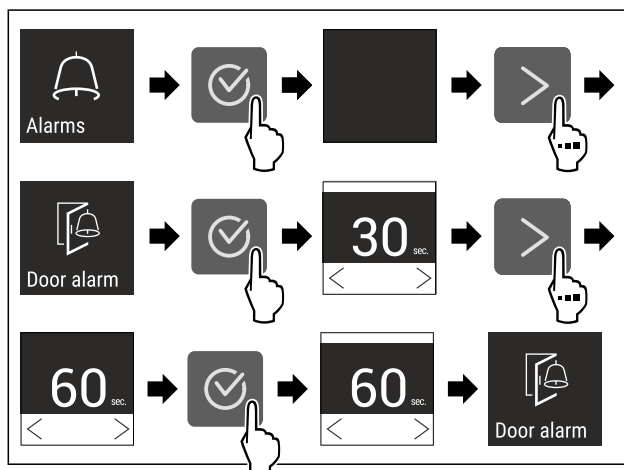

Fig. 55 Example illustration: Switch door alarm from 30 seconds to 60 seconds.

- ▶ Carry out action steps according to the illustration.
- ▷ The door alarm is set.

### Deactivating the door alarm

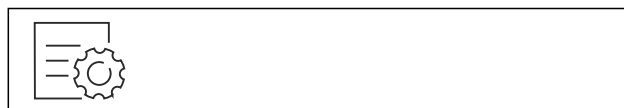

Fig. 56

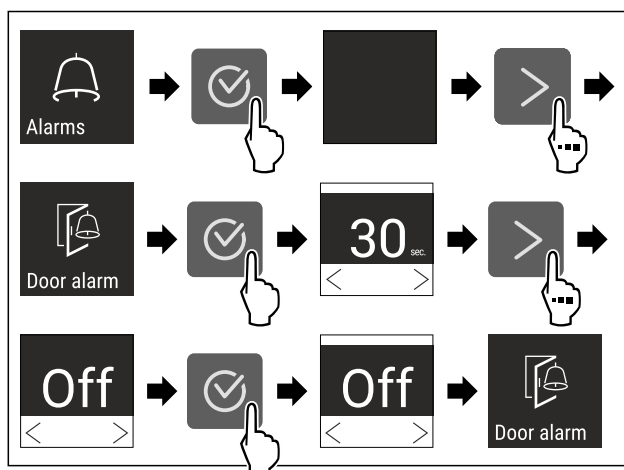

Fig. 57

- ▶ Carry out action steps according to the illustration.
- ▷ The door alarm is deactivated.

### 6.2.11 Alarm Sound



This function enables all alarm sounds, such as door alarm, to be switched on and off.



▶ Entry of the old settings code successful.

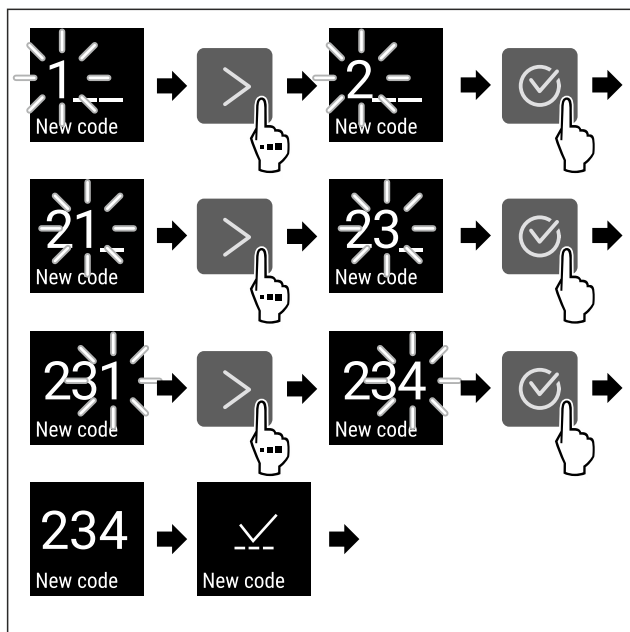

Fig. 68

- ▶ Carry out action steps according to the illustration.
- ▶ Entry of the new settings code successful.

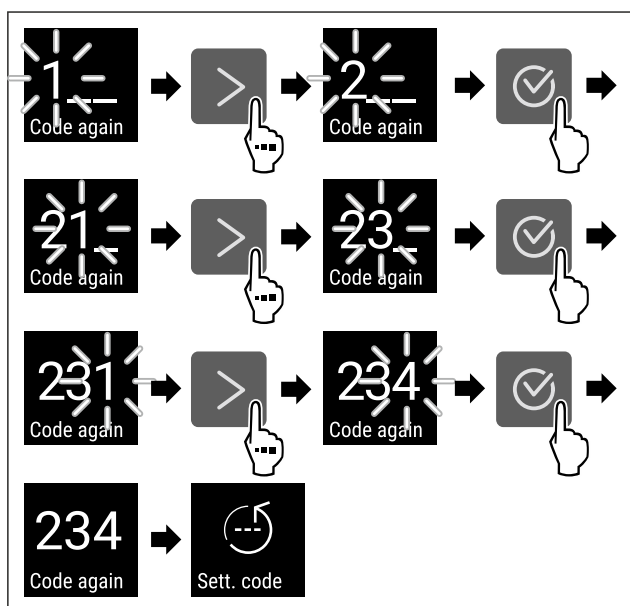

Fig. 69

- ▶ Carry out action steps according to the illustration.
- ▶ Confirmation of the new settings code successful.
- ▶ The settings code has been changed.

## Resetting the settings code

The settings code for the settings menu access protection has been forgotten or is not known.

- ▶ Reset appliance to factory settings (see 6.2.23 Resetting to factory settings ).
- ▶ The appliance is reset to the original settings.
- ▶ The factory-set settings code is: **1 1 1**

## 6.2.14 Language



This setting allows the display language to be set.

## Setting language



Fig. 70

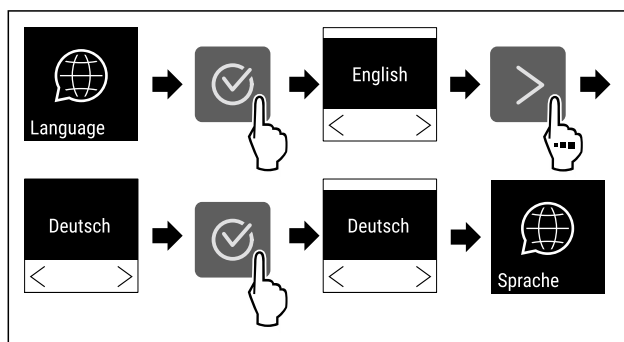

Fig. 71

- ▶ Carry out action steps according to the illustration.
- ▶ The selected language is set.

## 6.2.15 Device information



Use this function to indicate the model name, index, serial number and service number of your device. You will need the device information when you contact customer service. (see 9.3 Customer Service)

This function also opens the Advanced menu. (see 3 Functionality of the Touch display)

### Indicating the device information



Fig. 72



Fig. 73

- ▶ Carry out action steps according to the illustration.
- ▶ Display indicates device information.

## 6.2.16 Operating hours



The display shows the appliance operating hours.

### Displaying operating hours



Fig. 74

# Controls



Fig. 75

► The operating hours appear.

## 6.2.17 Software



Use this function to indicate the software version of your device.

### Indicating the software version



Fig. 76

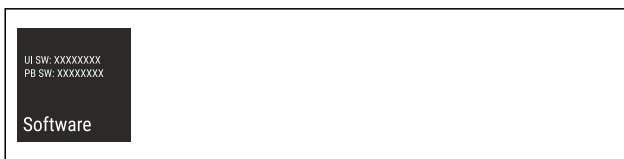

Fig. 77

► Carry out action steps according to the illustration.  
 ► Display indicates software version.

## 6.2.18 Sensor calibration



You can use sensor calibration to compensate for differences between the set temperature and the actual existing temperature. To do this, use calibrated measuring equipment to determine the actual existing temperature.

Setting range: +/- 3 Kelvin in 0.1 Kelvin increments.

### Calibrating the sensor



Fig. 78

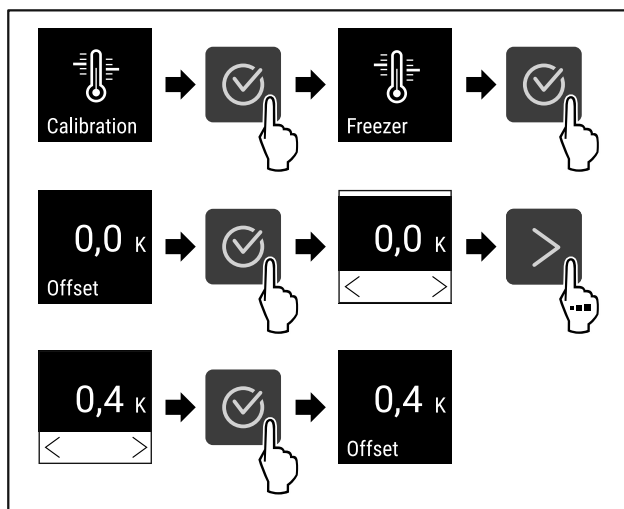

Fig. 79

► Carry out action steps according to the illustration.  
 ► The sensor is calibrated.

### Note

The calibrated temperature is indicated on the display within two hours.

## 6.2.19 Maintenance interval reminder



Setting for the time interval after which a maintenance reminder is issued.

The following values can be set:

- 7 days
- 14 days
- 30 days
- 60 days
- 90 days
- 180 days
- 360 days
- 720 days
- 1080 days
- Off

### Setting maintenance interval reminder

The following steps describe how the maintenance interval is set.



Fig. 80

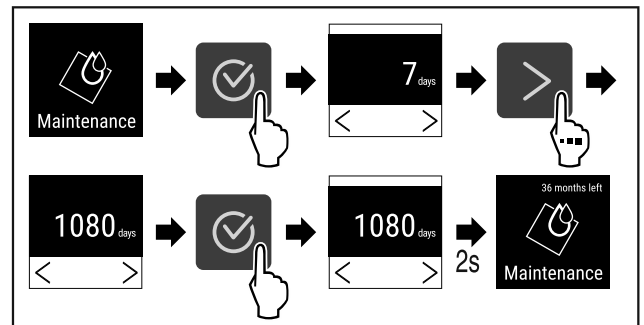

Fig. 81

► Carry out action steps according to the illustration.  
 ► The time interval, after which the maintenance reminder is issued, is set.  
 ► The remaining time is displayed.

## 6.2.20 Alarm simulation



You can use this function to simulate a temperature alarm in the appliance, e.g. to check whether a safety device triggers correctly. The safety device is connected to the potential-free alarm output. (see 7.3 Interfaces)

### Starting the alarm simulation



Fig. 82

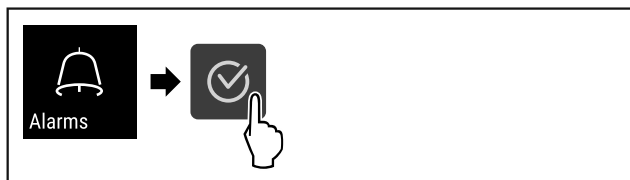

Fig. 83

► Carry out action steps according to the illustration.

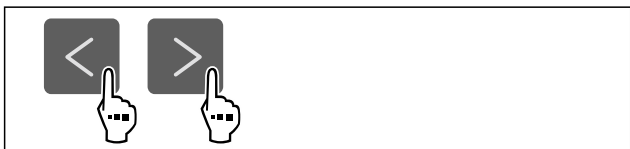

Fig. 84

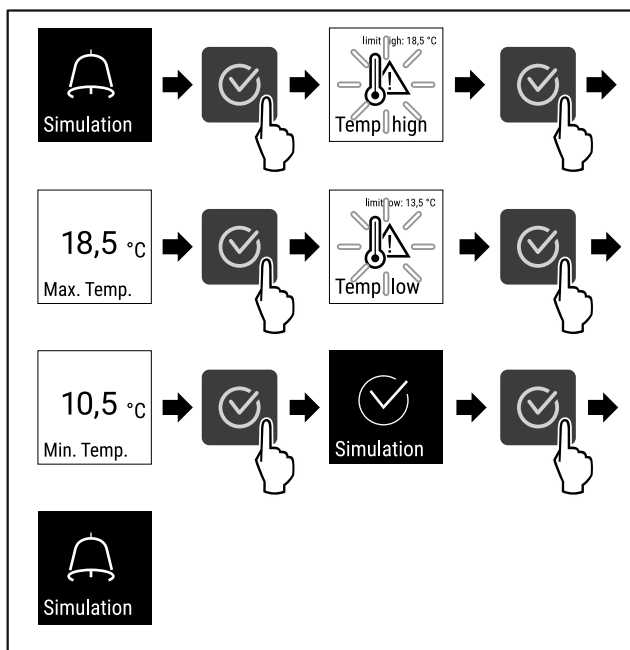

Fig. 85

► Carry out action steps according to the illustration.  
 ► The simulation has been performed.  
 ► Connected safety devices should have triggered.

## 6.2.21 Alarm forwarding



You can use this function to forward one or several alarms to an external alarm receiver. The alarm receiver is connected to the potential-free alarm output on the appliance. (see 7.3 Interfaces)

You can select the following settings:

- Alarm type:
  - Door alarm
  - Temperature alarm
  - Door alarm and temperature alarm
  - All
- Confirm:
  - **Yes:** The alarm is confirmed on the appliance and the external, connected receiver.
  - **No:** The alarm is confirmed on the appliance and remains active on the receiver until the fault is rectified.
- Refresh (only visible if you select “Yes” when confirming):
  - **Yes:** Alarm repeats.

**Temperature alarm** depending on the set time (see 6.2.9 Temperature alarm )  
 (If you set the alarm delay time to “0”, there is no alarm repetition on the alarm relay.)

**Door alarm** after 1 or 4 minutes\* (see 6.2.10 Door alarm )

- **No:** The alarm is confirmed permanently.

### Activating alarm forwarding



Fig. 86

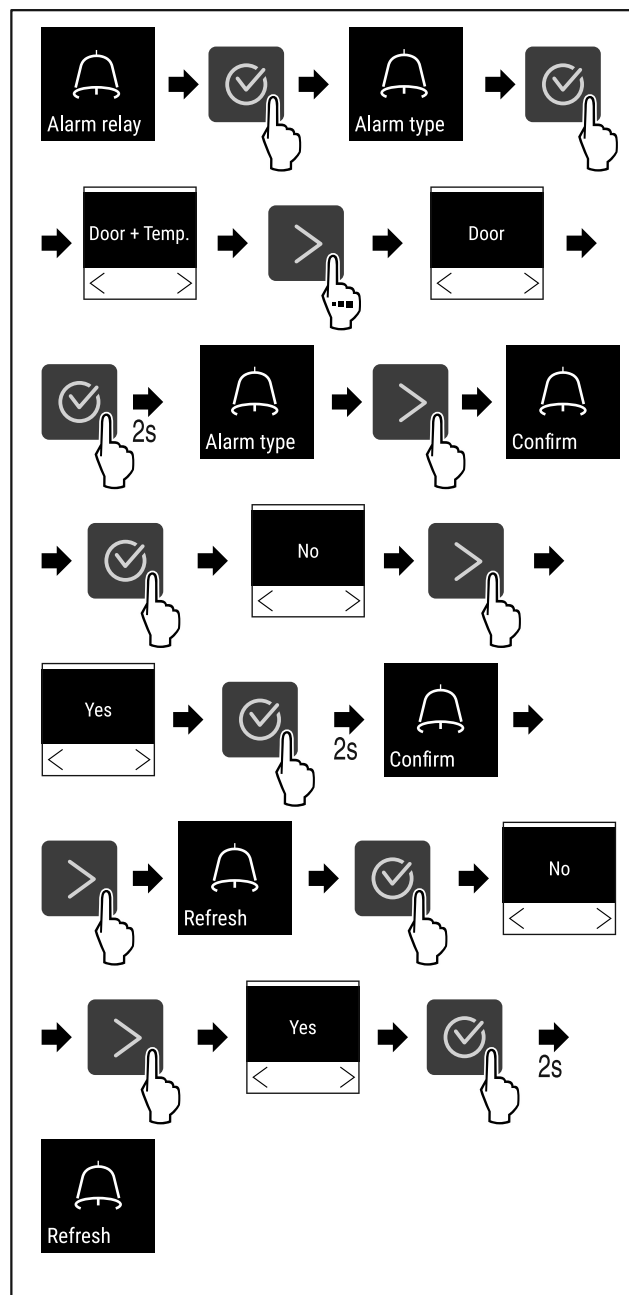

Fig. 87

► Carry out action steps according to the illustration.  
 ► Alarm forwarding is set.

## 6.2.22 Demo mode



Demo mode is a special feature for dealers who want to demonstrate appliance features. If you activate demo mode, all refrigeration functions are deactivated.

If you switch on your appliance and a “D” appears on the status display, demo mode is already activated.

If you activate and then deactivate demo mode, the appliance will be reset to factory defaults. (see 6.2.23 Resetting to factory settings )

### Activating demo mode



Fig. 88

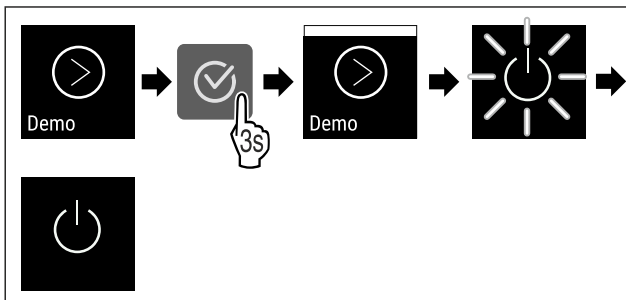

Fig. 89

- ▶ Carry out action steps according to the illustration.
- ▶ Demo mode is activated.
- ▶ Appliance is switched off.
- ▶ Switch on the appliance. (see 4.1 Switching on appliance (first use))
- ▶ “D” appears in the status display.

### Deactivating demo mode



Fig. 90

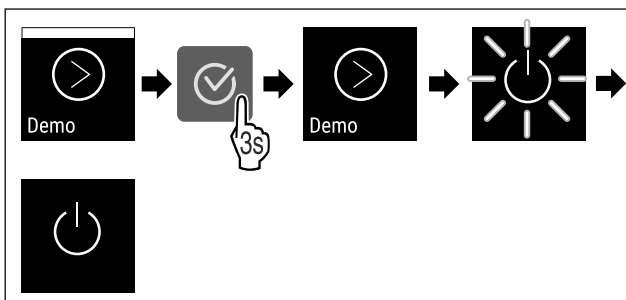

Fig. 91

- ▶ Carry out action steps according to the illustration.
- ▶ Demo mode is deactivated.
- ▶ Appliance is switched off.
- ▶ Switch on the appliance. (see 4.1 Switching on appliance (first use))
- ▶ Appliance is reset to factory settings.

## 6.2.23 Resetting to factory settings



Use this function to reset all settings to factory defaults. All settings you have made so far are reset to their original settings.

### Performing a reset



Fig. 92

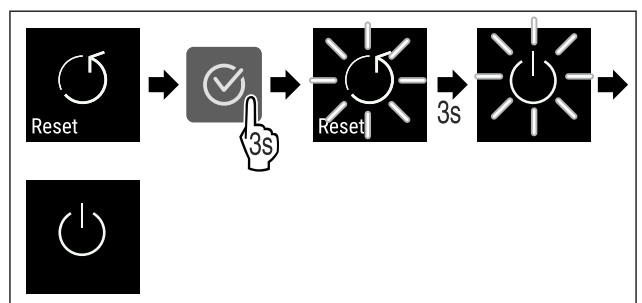

Fig. 93











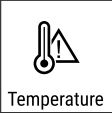

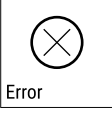
- ▶ Carry out action steps according to the illustration.
- ▶ Device is reset.
- ▶ Device is switched off.
- ▶ Restart the device. (see 4.1 Switching on appliance (first use))

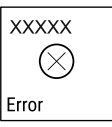
## 6.3 Messages



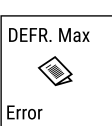

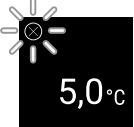
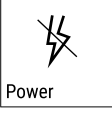



### 6.3.1 Warnings

Warnings are issued by means of an audio signal and visually via a symbol on the display. The signal gets louder until the warning is acknowledged.

Message	Cause	Remedy
<p>Door open</p> <p><b>Door open</b></p>	<p>This message appears if the door is open for too long.</p>	<p>Close the door.</p> <p>Press the confirmation button.</p> <p>Alarm is ended.</p> <p><b>Note</b></p> <p>You can set how long it takes for this message to appear (see 6.2.10 Door alarm ).</p>

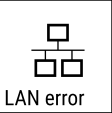

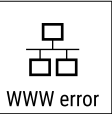

Message	Cause	Remedy
 <p>Temperature</p> <p><b>Temperature alarm</b></p>	<p>This message appears if the temperature does not match the set temperature. Reasons for the differences in temperature can be:</p> <ul style="list-style-type: none"> <li>- Warm items for refrigeration have been placed inside.</li> <li>- Too much warm room air flowed in when rearranging and removing refrigerated products.</li> </ul> <p>The power was cut off for a prolonged period.</p>	<p>Press the confirmation button. Warmest temperature is displayed.</p>  <p>Press the confirmation button. The current temperature flashes and the display alternates with the temperature alarm symbol until the set temperature is reached.</p>  <p>Check the quality of the refrigerated goods.</p>
 <p>Error</p> <p><b>Error</b></p>	<p>The appliance is defective, there is an appliance fault or a component of the appliance is faulty.</p>	<p>Transfer refrigerated goods. Press the confirmation button. Error code is displayed.</p>   <p>Press the confirmation button. If present, another error code is indicated.</p> <p><b>or</b></p> <p>Status screen with flashing error symbol is displayed. Pressing the navigation buttons indicates error code(s) again. Note the error code(s) and contact customer service.</p>  
	<p>Message indicates unplanned defrosting behaviour. For example, the evaporator may ice up abnormally due to prolonged openings of the door and the defrosting time may no longer be sufficient.</p>	<p>Press the confirmation button. <b>DEFR. MAX</b> is displayed.</p>   <p>Press the confirmation button. Status screen with flashing error symbol is displayed.</p>   <p>Pressing the navigation buttons displays the error code again.</p> <p>Move refrigerated goods and defrost the appliance by hand. Alternatively, defrosting can be started manually.</p> <p>If the message is displayed repeatedly and the causes listed do not apply, contact customer service. (see 9.3 Customer Service)</p>
 <p>Power</p> <p><b>Power failure</b></p>	<p>The message appears after an interruption in the power supply if the temperature is above the alarm limit when the power returns.</p>	<p>Press the confirmation button. The warmest temperature is displayed.</p>  <p>Press the confirmation button. Alarm is cancelled and current temperature is indicated. Check the quality of the refrigerated goods.</p> 

# Features

Message	Cause	Remedy
 <b>WiFi error</b> <b>WLAN error</b>	WLAN connection is interrupted.	Check the connection. Press the confirmation button. Alarm is ended. 
 <b>WWW error</b> <b>WLAN WWW error</b>	The message appears if there is no Internet connection via WLAN.	Check the connection. Press the confirmation button. Alarm is ended. 
 <b>LAN error</b> <b>LAN error</b>	LAN connection is interrupted.	Check connection and network cable. Press the confirmation button. Alarm is ended. 
 <b>WWW error</b> <b>LAN WWW error</b>	The message appears if there is no Internet connection via LAN.	Check the connection. Press the confirmation button. Alarm is ended. 

## 6.3.2 Reminder

Reminders appear when you are being asked to do something. They are issued by means of an audio signal and visually via a symbol on the display. Acknowledge the message by pressing the confirmation button.

Message	Cause	Remedy
 <b>Maintenance</b> <b>Maintenance reminder</b>	The message appears when the timer for the set maintenance interval has expired.	 Press the confirmation button. Alarm is ended. <b>Note</b> The maintenance interval can be set (see 6.2.19 Maintenance interval reminder ).
 <b>Recording</b> <b>Recording reminder</b>	This message appears when the temperature recording memory (999 hours) is full.	 Press the confirmation button. Alarm is ended. The oldest data is overwritten. <b>Note</b> The temperature recording can be reset (see 6.2.7 Temperature recording ).

## 7 Features

### 7.1.1 Locking appliance

#### 7.1 Safety lock

The lock in the appliance door is equipped with a safety mechanism.

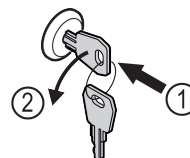

Fig. 94 Example illustration

- ▶ Insert key.
- ▶ Turn key anticlockwise by 90°.
- ▶ The appliance is locked.

## 7.1.2 Unlocking appliance

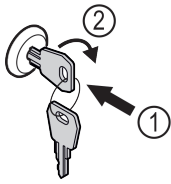

Fig. 95 Example illustration

- ▶ Insert key Fig. 95 (1).
- ▶ Turn key clockwise by 90° Fig. 95 (2).
- ▶ The appliance is unlocked.

## 7.2 Sensors

The appliance can be equipped with the following sensors for temperature monitoring:

- C sensor

### 7.2.1 C sensor (control sensor)

The C sensor is permanently installed and regulates the interior temperature of the appliance. You can calibrate the C sensor if necessary. (see 6.2.18 Sensor calibration )

## 7.3 Interfaces

There are various connection options on the back of the appliance.

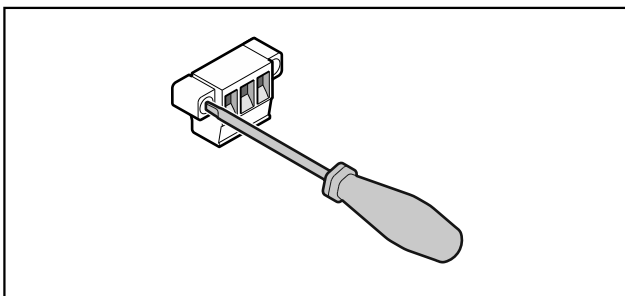

Fig. 96

### Note

Screws secure the plugs. To enable disconnection of the plugs, loosen the screws on the left and right.

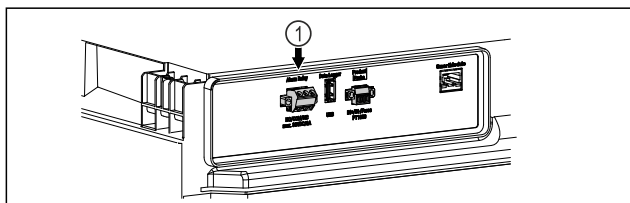

Fig. 97

- (1) Potential-free alarm output

### 7.3.1 Potential-free alarm output



### WARNING

Risk of injury due to electric shock!

- ▶ The appliance may only be connected to an external alarm device by trained specialist personnel.

These three contacts can be used to connect a visual or an acoustic alarm device. The connection is designed for a maximum of **30 V (DC) - 8 A** from a safety low voltage source SELV (**minimum current 150 mA**).

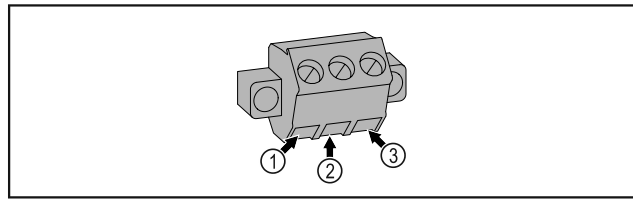

Fig. 98

- (1) NO (normally open)  
Connection for indicator lamp, which is active in normal operation or when the appliance is switched off.
- (2) COM (common)  
External voltage source
- (3) NC (normally closed)  
Connection for alarm lamp or audible alarms, which is active when an alarm is triggered or there is a lack of power supply.

## 8 Maintenance

### 8.1 Maintenance schedule

Maintenance work is to be performed at regular intervals to ensure proper appliance function.



### CAUTION

Danger of injury and damage due to unprofessional maintenance work!

Personal injury and material damage.

- ▶ Maintenance work may only be performed by trained specialist personnel.



### WARNING

Short-circuit hazard due to live parts!

Electric shock or damage to the electronics.

- ▶ **Switch off the appliance.**
- ▶ Pull out mains plug or switch off fuse.

### Note

A maintenance reminder function can be activated. (see 6.2.19 Maintenance interval reminder )

### Note

We recommend creating a maintenance log in which all work (repairs, checks) performed is documented.

### Note

Liebherr recommends yearly maintenance. For an individual offer, please contact Customer Service (see 9.3 Customer Service) .

# Maintenance

Component	Activity	Maintenance interval
Sheet metal parts	Check for damage and corrosion. Replace damaged parts: (see 9.3 Customer Service)	Yearly
Door, hinges	Check alignment , ease of movement, and tight fit.	Yearly
Lock, door handle *	Check for ease of movement and tight fit.	Yearly
Door seal	Check for damage, wear, and tight fit. A replacement door seal is available via Customer Service (see 9.3 Customer Service) .	Yearly
Sensor	Calibrate sensor. (see 6.2.18 Sensor calibration )	Yearly
Sensor feedthrough	Check that the sealing compound is intact.	Yearly
Surfaces	Cleaning (see 8.3 Cleaning the appliance)	Recommendation: monthly or as required/specified at installation location
Surfaces	Disinfection Liebherr has tested the following disinfectants: Dismozon pur 1 % Lösung (Bode Chemie), Suma Quicksan (Diversey), Incidin Extra N (Ecolab Healthcare), Acrylan (Antiseptica chem.-pharm. Produkte), Buraton 10 F (Schülke und Mayr), Frankocid N (Franken Chemie), Apesin DSR 50 (Tana), Nüscosept Spray (Dr. Nüsken), Melsept SF (B. Braun Melsungen), Kohrsolin (Bode Chemie), Neoquat S (Dr. Weigert), Incidin Rapid (Ecolab Healthcare), Bacillocid Spezial (Bode Chemie), Neoform K Spray (Dr. Weigert), Apesin Desinf. Spray (Tana), Nüscosept 100 (Dr. Nüsken), Antisept T (Fink Tec), Apesin AP 100 0,50% Lösung (Tana), Perform Pulver 2% Lösung (Schülke und Mayr) Observe the operating instructions of the respective manufacturer. If disinfectants other than those stated are used, test them on a less exposed area first.	Recommendation: monthly or as required/specified at installation location
Installation location, appliance	Decontamination The appliance is suitable for room decontamination with hydrogen peroxide H <sub>2</sub> O <sub>2</sub> . In this context, the values of the following application specifications must not be exceeded: Concentration: maximum 250 ppm. Humidity: maximum 85%. Maximum permissible room temperature as per climate class. (see 2.4 Range of use of appliance)	Recommendation: as required/specified at installation location, maximum 2x per year
Fan air slots	Cleaning	Yearly
Alarm relay	Check plug connections for tight fit.	Yearly
Network cable	Check for damage.	Yearly or When changing the location
Adjustable feet/rollers	Check that it is working properly, undamaged and that it is tight. Replace damaged parts. (see 9.3 Customer Service)	Yearly

## 8.2 Defrosting appliance



### WARNING

Improper defrosting of the appliance!  
Injuries and damage.

- ▶ Do not use mechanical equipment or other methods to speed up the defrosting process other than those recommended by the manufacturer.
- ▶ Do not use electrical heating or steam-cleaning appliances, naked flames or defroster sprays to defrost.
- ▶ Do not use sharp objects to remove ice.

To maintain the functionality of the appliance, we recommend defrosting it when there is a high buildup of ice. Icing in the interior is determined by the location (e.g. high humidity), settings on the appliance and incorrect user behaviour.

If automatic defrosting is insufficient, defrost the appliance manually:

- ▶ Switch off appliance. (see 6.2.2 Switching appliance on and off )
- ▶ Pull out mains plug.
- ▶ Store refrigerated items elsewhere.
- ▶ Leave appliance door open during defrosting process.
- ▶ Absorb any remaining defrost water with a cloth and clean the appliance.

## 8.3 Cleaning the appliance

### 8.3.1 Preparing



### WARNING

Short-circuit hazard due to live parts!  
Electric shock or damage to the electronics.

- ▶ **Switch off the appliance.**
- ▶ Pull out mains plug or switch off fuse.



### WARNING

Risk of fire

- ▶ Do not damage the refrigeration circuit.
- ▶ Empty the appliance.
- ▶ Pull out the mains plug.
- ▶ Observe the notes on transporting the appliance.

### 8.3.2 Cleaning housing

#### NOTICE

Improper cleaning!  
Damage to the appliance.

- ▶ Only use soft cleaning cloths and ph-neutral all-purpose cleaners.
- ▶ Do not use abrasive sponges or steel wool which may cause scratches.
- ▶ Do not use any sharp or abrasive cleaning agents, nor any that contain sand, chloride or acid.



### WARNING

Risk of injury and damage as a result of hot steam!  
Hot steam can lead to burns and can damage the surfaces.

- ▶ Do not use any steam cleaners!

#### NOTICE

Risk of damage due to short circuit.

- ▶ When cleaning the appliance, make sure no water gets into the electrical components.
- ▶ Wipe the housing down with soft, clean cloth. If very dirty, use lukewarm water with a neutral cleaner. Glass surfaces can also be cleaned with glass cleaner.
- ▶ Clean condenser coil each year. If the condenser coil is not cleaned, this significantly reduces the efficiency of the appliance.

### 8.3.3 Cleaning interior



### WARNING

Short-circuit hazard due to live parts!  
Electric shock or damage to the electronics.

- ▶ **Switch off the appliance.**
- ▶ Pull out mains plug or switch off fuse.



### WARNING

Risk of injury and damage as a result of hot steam!  
Hot steam can lead to burns and can damage the surfaces.

- ▶ Do not use any steam cleaners!

#### NOTICE

Improper cleaning!  
Damage to the appliance.

- ▶ Only use soft cleaning cloths and ph-neutral all-purpose cleaners.
- ▶ Do not use abrasive sponges or steel wool which may cause scratches.
- ▶ Do not use any sharp or abrasive cleaning agents, nor any that contain sand, chloride or acid.

#### Note

Do not damage or remove the type plate on the inside of the appliance. The type plate is important for Customer Service. (see 9.3 Customer Service)

- ▶ Open the door.
- ▶ Empty the appliance.
- ▶ Clean interior and equipment parts with lukewarm water and a little detergent. Do not use any gritty or acidic cleaning agent or any chemical solvent.

### 8.3.4 After cleaning

- ▶ Wipe appliance and equipment parts dry.
- ▶ Connect and switch on appliance.  
Once the temperature is sufficiently cold:
- ▶ put in items for refrigeration goods.
- ▶ Repeat cleaning regularly.
- ▶ Clean and remove dust from the refrigeration unit with heat exchanger once a year.

## 9 Customer help

### 9.1 Technical specifications

Temperature range	
Freezing	-9 °C to -30 °C

Maximum load per shelf <sup>A)</sup>			
Appliance width	550 mm	600 mm	750 mm
Grid shelves	--	45 kg	60 kg
Glass shelf	40 kg	40 kg	40 kg
Drawer (freezer appliances)	15 kg	15 kg	15 kg

A) Heavier loads may result in a slight bending of the shelves.

Net capacity
See net capacity on the type plate. (see 2.2 Overview of the appliance and equipment)

WLAN frequency specification	
Frequency band	2.4 GHz
Maximum radiated power	<100 mW
Purpose of the wireless equipment	Integration in the local WiFi network for data communication

Set-up conditions	
Degrees of pollution (surrounding the appliance)	PD2

Set-up conditions	
Ambient temperature	+10 °C to +35 °C
Maximum relative ambient moisture	75%, not condensing
Maximum operating elevation (metres above sea level)	2000 m

Electrical values	
Nominal voltage	220-240 V ~
Frequency	50 Hz
Connected load	2,0 A
Maximum mains fluctuation	+/-10%
Overvoltage categories	II

## 9.2 Technical fault

Your appliance is designed and built to ensure it works reliably and has a long service life. In the unlikely event that a fault occurs during operation, please check whether the fault is due to an operating error. If this is the case, you will be charged for the cost incurred even if this falls within the warranty period.

You can fix the following faults yourself.

### 9.2.1 Appliance function

Defect	Cause	Remedy
<b>The appliance is not working.</b>	→ The appliance is not switched on.	▶ Switch on the appliance.
	→ The mains plug is not properly plugged into the socket.	▶ Check the mains plug.
	→ There is something wrong with the fuse in the socket.	▶ Check fuse.
	→ Power cut	▶ Keep the appliance closed. ▶ If necessary move the refrigerated/frozen items to another fridge or freezer if the power is off for a prolonged period.
	→ The IEC socket is not plugged into the appliance correctly.	▶ Check the IEC socket.
<b>Temperature is not cold enough.</b>	→ The appliance door is not closed properly.	▶ Close appliance door.
	→ Ventilation is not sufficient.	▶ Clear ventilation grille and clean it.
	→ The ambient temperature is too high.	▶ Ensure the correct ambient conditions: (see 2.4 Range of use of appliance)
	→ The appliance was opened too many times or for too long.	▶ Wait to see if the appliance goes back to the required temperature by itself. If not, contact Customer Service. (see 9.3 Customer Service)
	→ The temperature is set incorrectly.	▶ Set a colder temperature and check after 24 hours.
	→ The appliance is too close to a heat source (oven, radiator, etc).	▶ Change where the appliance or the heat source are located.
<b>Frost formation on the housing frame and/or on the inside of the door.</b>	→ Door seal is damaged.	▶ Replace the door seal.
	→ You have set the temperature too cold or you have not opened the door often enough.	▶ The appliance is not malfunctioning; simply remove any condensation with a cloth.

## 9.3 Customer Service

First check whether you can remedy the fault yourself. If this is not the case, please contact Customer Service.

You can find the address in the enclosed brochure "Liebherr-Service" or at [home.liebherr.com/service](http://home.liebherr.com/service).



### WARNING

Unprofessional repair!  
Injuries.

- ▶ Have any repairs and action - not expressly specified - on the appliance and mains cable carried out by service personnel only. (see 8 Maintenance)
- ▶ A damaged mains cable may only be replaced by the manufacturer, the manufacturer's Customer Service or a similarly qualified person.
- ▶ In the case of appliances with an IEC connector, the change may be made by the customer.

### 9.3.1 Contacting Customer Service

Make sure you have the following appliance data at the ready:

- Appliance name (model and index)
- Service no. (Service)
- Serial no. (S no.)
- ▶ Access the appliance information via the display (see 6.2.15 Device information ).
- or-
- ▶ Refer to the type plate for appliance information. (see 9.4 Type plate)
- ▶ Note down appliance information.
- ▶ Inform Customer Service: Report faults and the appliance information.
- ▶ This will help us to provide a fast and focussed service.
- ▶ Follow any further instructions provided by Customer Service.

## 9.4 Type plate

The type plate is inside the appliance. See appliance overview.

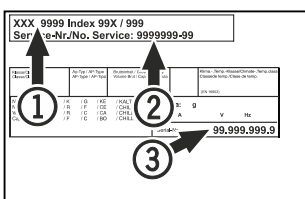

Fig. 99

- (1)** Appliance designation
- (2)** Service No.
- (3)** Serial No.

## 10 Shutting down

- ▶ Empty the appliance.
- ▶ Switch off the appliance.
- ▶ Pull the mains plug out of the socket.
- ▶ Remove the IEC socket if required: Pull the IEC socket out of the appliance plug and move it to the left and right at the same time.
- ▶ Clean appliance (see 8.3 Cleaning the appliance) .
- ▶ If present: Remove the covers and insulation from the sensor feed-through to prevent mould forming.
- ▶ Leave the door open so that no bad odours form.

### Note

Damage to the appliance and malfunctions!

- ▶ After shutting down, only store the appliance at the permitted room temperature of between -10 °C and +50 °C.

## 11 Disposal

### 11.1 Preparing appliance for disposal



Liebherr uses batteries in some of its appliances. In the EU, for environmental reasons, legislation obliges the end user to remove these batteries before disposing of old appliances. If your appliance contains batteries, a corresponding notice is attached.

**Lamps** If you can remove the lamps yourself without destroying them, also remove these before disposal.

- ▶ Take the appliance out of operation.
- ▶ If possible: remove lamps without destroying them.

### 11.2 Disposing of the appliance in an environmentally friendly manner



The appliance still contains valuable materials and must be disposed of separately from unsorted municipal waste.



Dispose of batteries separately from the old appliance. To do this, you can return the batteries free of charge to retailers as well as recycling centres and collection centres for recyclable materials.

**Lamps**

Dispose of removed lamps via the respective collection systems.

For Germany:

You can dispose of the appliance free of charge via the class 1 collection containers at the local recycling and recyclable material collection centres. When purchasing a new fridge/freezer, if the sales area > 400 m<sup>2</sup>, retailers will also take back the old appliance free of charge.



### WARNING

Leaking coolant and oil!

Fire. The coolant contained in the appliance is eco-friendly, but also flammable. The oil contained in the appliance is flammable. Escaping coolant and oil can ignite if the concentration is high enough and in contact with an external heat source.

- ▶ Do not damage the pipelines of the coolant circuit and the compressor.

- ▶ Observe the notes on transporting the appliance.
- ▶ Transport the appliance without damaging it.

## Additional information

---

- ▶ Dispose of batteries, lamps and the appliance according to the above specifications.

## 12 Additional information

Further information on warranty conditions can be found in the enclosed service brochure or on the Internet at <https://home.liebherr.com>.





[home.liebherr.com/fridge-manuals](https://home.liebherr.com/fridge-manuals)

**EN** base unit freezer

Issue date: 20260220

**Part number index: 7083717-00**

Liebherr Hausgeräte Lienz GmbH  
Dr.-Hans-Liebherr-Strasse 1  
A-9900 Lienz  
Österreich